

ROBOTERA



# XHAND1

Full Direct Drive Gives True Freedom



Scan for More

# XHAND1

The XHAND1 by ROBOTERA is a full direct-drive humanoid five-finger dexterous hand developed in-house. It is equipped with 12 active degrees of freedom, comparable in size to a human hand, capable of replicating complex human hand movements, and can operate various tools in different forms.

Each finger of the XHAND1 by ROBOTERA supports a high-resolution 3D tactile array sensor that covers the fingertip in a 270° wraparound configuration. This sensor provides precise 3D force, tactile feedback, and temperature sensing. Additionally, the hand boasts powerful gripping strength, with a maximum single-hand gripping force of 80 N and a maximum load capacity of 25 kg, enabling it to handle tasks ranging from delicate operations to heavy object handling.

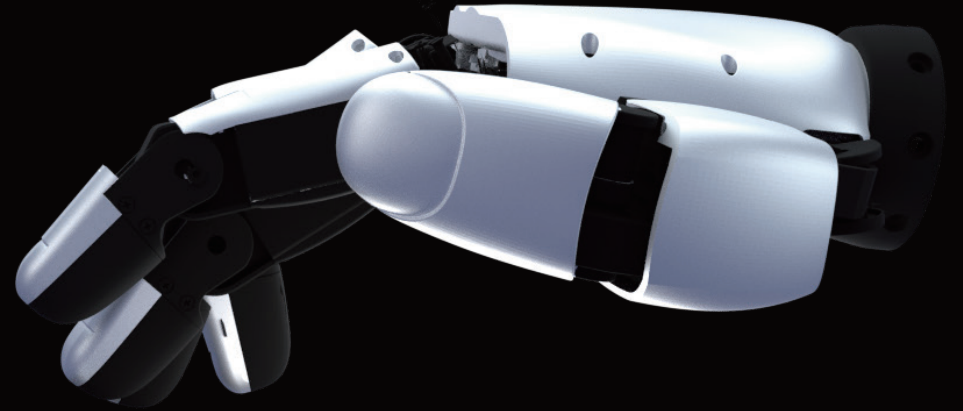

# XHAND 1

The First Dextrous Hand with Direct-drive Module in Each Joint



High-power-density Cordless Motor



Low-damping Small-backlash Reducer



High-power Driver & High-precision Encoder

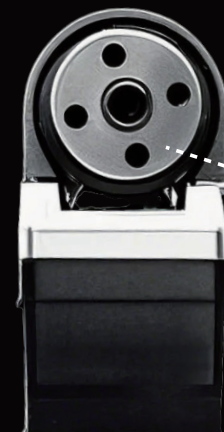

Self-developed Integrated Joint Module

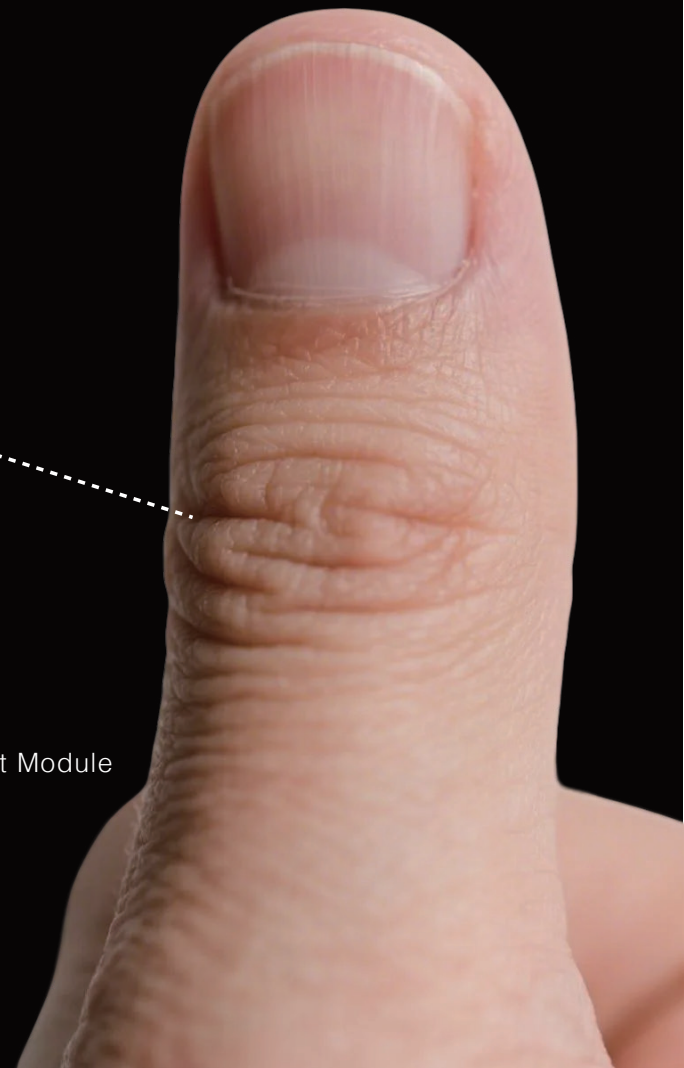

# Full Direct Drive - Ultra Flexibility



- 12 fully active DoF in total
- The only five-finger hand comparable in size to a human hand with DoF > 10



- The index finger can swing  $\pm 15^\circ$  sideways
- Replicating complex manipulation, such as twisting a bottle cap



- A wide range of motion
- Opposable capability for the thumb as shown in positions 1-6 (in the Kapandji test)



## Full Direct Drive - The Power Beast

- Maximum load of 25 kg, maximum grip strength of 80 N, far surpassing the linkage and tendon-driven solutions of the same size.



## Full Direct Drive - The Hand of Game

- The full direct-drive solution uses gears for direct drive, offering faster speed than linkage and tendon-driven solutions.
- The motor has strong performance, with a torque greater than 1 Nm.

# 10CPS

\*CPS (Clicks Per Second)

# Full Direct Drive - Ultra Sensitivity

- Each finger is equipped with a 270° fingertip-wrapped high-resolution (>100 points) tactile array sensor, with an accuracy of up to 0.05 N. It provides 3D force, tactile, and temperature information, delivering superior gripping performance compared to flat sensors.

# 270°

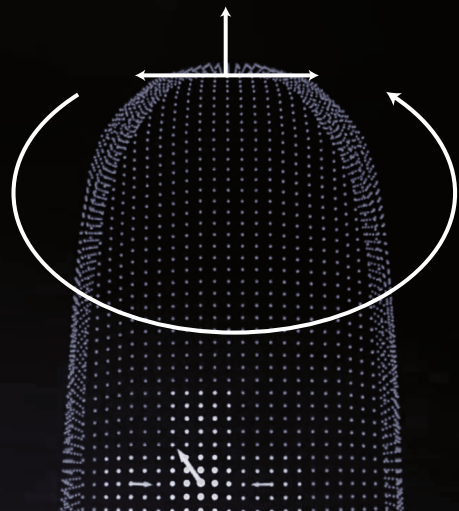

# Full Direct Drive - The AI Training Expert



- More biomimetic in force control
- Allowing for finer grip of flexible and fragile objects with higher tolerance
- Enabling more complex and precise dexterous operations when combined with tactile sensing

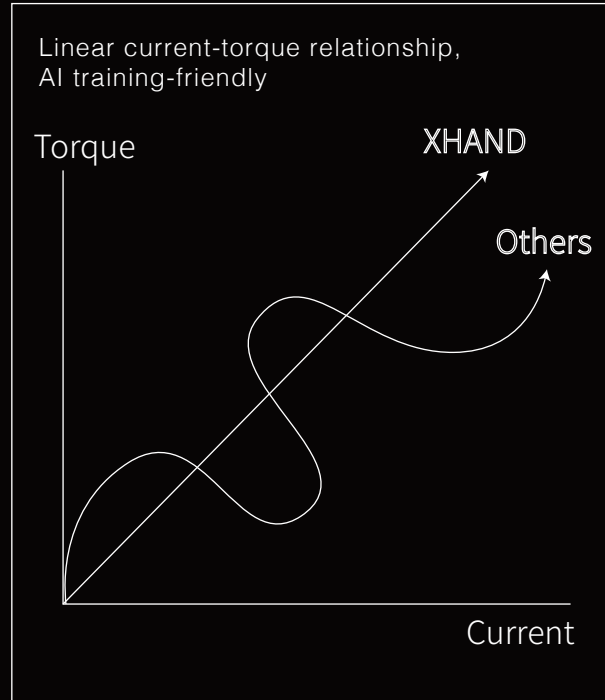

- No nonlinear transmission mechanism
- Simplifies the nonlinear parameters and algorithm conversion relationships
- More AI training-friendly



- More fault tolerance with back drive capability
- Improving strategy generalization
- Supports drag-and-teach



# Full Direct Drive - Your Lifelong Friend

- No elastic component, preventing wear and tear from loosening or tightening
- Screwless mechanism reduce friction, won't suffer from impact wear due to the push rod's self-locking
- Power-on, buffer the impact when obstructed
- Power-off, resist to accidental impacts and drops

Lifespan

>1 million cycles



\*A longer lifespan than other similar products (from 90% of clients' feedback)

# Developer Friendly



- Supports MR and glove teleoperation
- Compatible with ROS1 and ROS2
- Supports the Ubuntu (Linux) operating system
- Running on x64 and ARM chip architectures



- EtherCAT/RS485, TwinCAT
- Compatible with xARM, Realman, UR, and other robotic arms

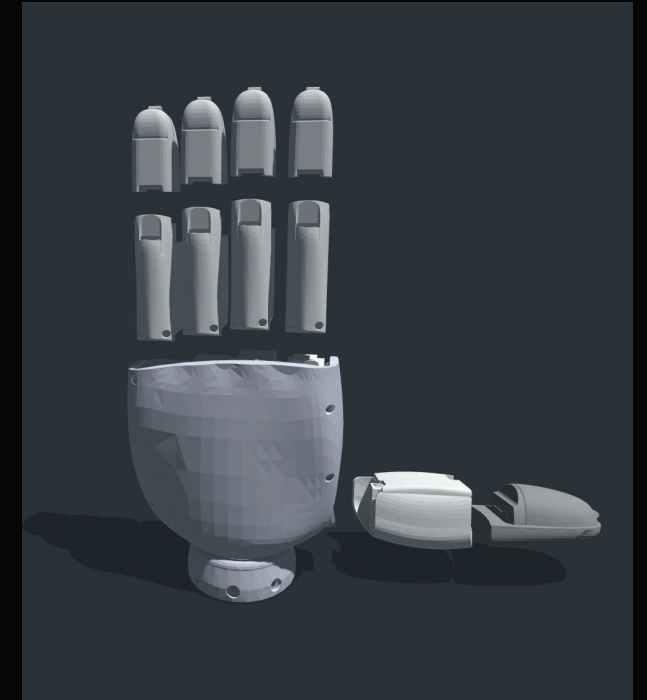

- Precise URDF, even support tactile sensing simulation

# Application: Reinforcement Learning

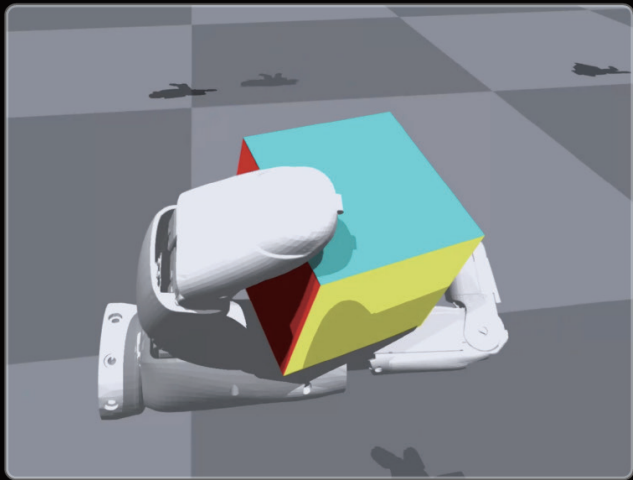

Issac gym

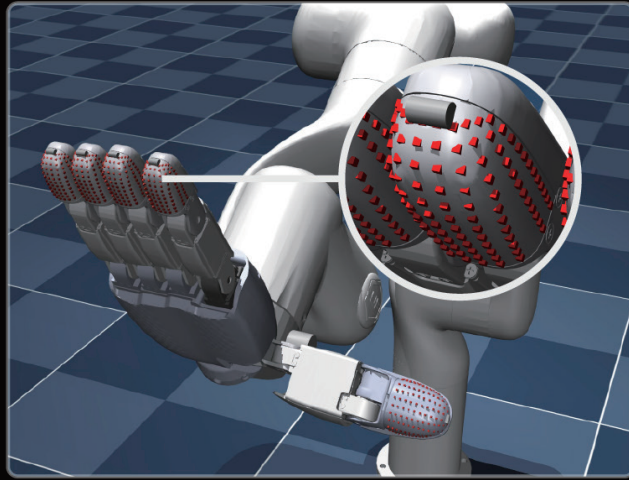

Mujoco

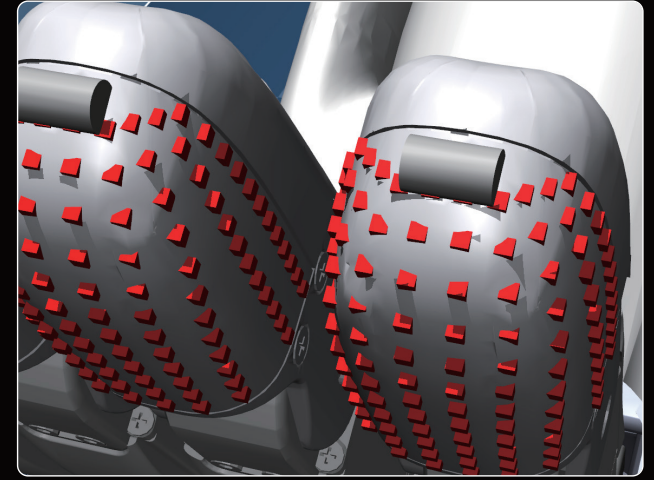

Fully-actuated hand that supports tactile sensing simulation

# Application: Teleoperation Full Solution



Vision Pro Teleoperation



Manus Gloves



Pico/Meta Quest

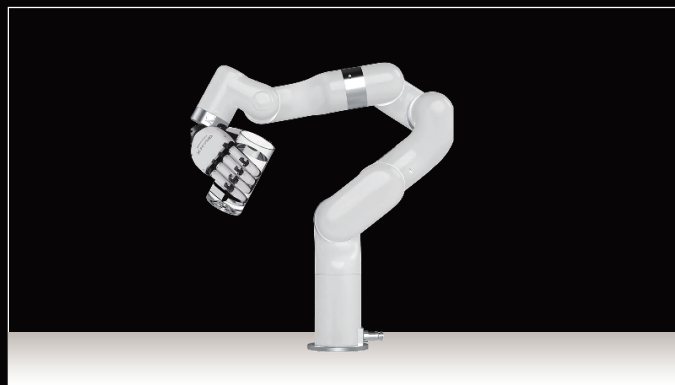

Robotic Arm



Humanoid Robot

# Application: Designed for the humanoids



- Human hand-sized



- Aesthetic industrial design



- Operate human tools



- Compliant Human-Machine Interaction



- Supports EtherCAT communication, enabling high-speed Multi-concurrent real-time control

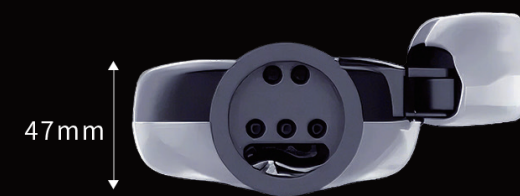
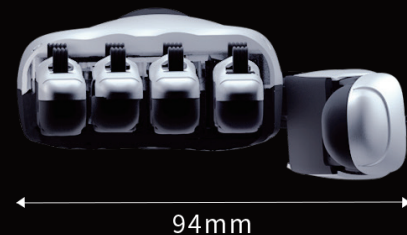
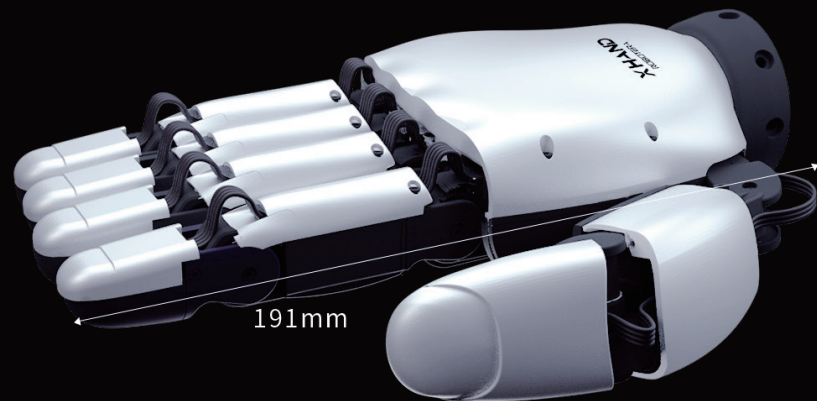

Weight	1100 g	Max Grip Strength	15 N (tip of the finger) 80 N (whole hand)
Dimensions (L x W x T)[1]	191 mm x 94 mm x 47 mm (The size of an adult's hand)	Max Payload	5 Kg (single finger) 25 Kg (palm facing up)
Active DoF (Total)	12	Thumb Farthest Opposition	Little Pinky
Passive DOF (Total)	0	Open/close repetition speed	>2Hz
DoF Allocation	Thumb x 3, Index Finger x 3, Middle Finger x 2 Ring Finger x 2, Little Finger x 2	Back-drive Damping (Backdrivable)	≤0.1 Nm
Thumb Actuation/Transmission	3 gear-driven force-controlled joint module	Tactile Coverage	Five-finger 270° three-dimensional circumferential tactile array sensing
Four-finger Actuation/Transmission	9 gear-driven force-controlled joint module	Tactile Resolution (whole hand)	12x10 (270° encircling per fingertip) x 5
Fingertip Configuration	Round or Rounded Fingertips	Tactile Sensing Dimensions	Three-dimensional force sensing (Including tangential forces X and Y)
Lateral Swing	-15°~+15° (Index)	Communication Interface	EtherCAT, RS485(USB)
Fingertip Repeat Positioning Accuracy[2]	±0.20 mm	Communication Rate	EtherCAT: 100MHz, RS485: 3MHz
Control Modes	Position control (low damping/high damping mode), current-loop force control, force-position control	No-load Grasp Cycles	1,000,000cycles

[1] The data is measured when the dexterous hand is placed flat. [2] The data is measured under load.

# ROBOTERA



Please Scan

For more inquiries and user tips

Email: [xhand@robotera.com](mailto:xhand@robotera.com)

[www.robotera.com/en/](http://www.robotera.com/en/)